

GENERAL PRODUCT SPECIFICATIONS

**VENEERS**

All exposed surfaces are offered in hand selected veneers. All veneer surfaces are book-matched resulting in superior wood grain aesthetics. aesthetics.

**WORK SURFACES**

Tops are 1.5" thick. Desks have profiled edges front and back and flush side panels. All worksurface height tops also have chemically impregnated polycell backer for additional worksurface durability.

**FINISH**

A multi-step modified polyurethane finish is applied to all finished cases.

**STANDARD FINISHES:**

- #100 CLEAR MAPLE
- #101 HONEY MAPLE
- #102 IMPERIAL CHERRY
- #103 AMARETTO CHERRY
- #104 CHAMPAGNE CHERRY
- #105 LIGHT CHERRY
- #106 CHESTNUT CHERRY
- #107 AMERICAN CHERRY
- #108 CLARET CHERRY
- #109 CABERNET CHERRY
- #119 BEECH
- #120 IMPERIAL MAPLE
- #121 COFFEE
- #122 PRIMA VERA-PLAIN SLICED
- #123 PRIMA VERA-BROKEN STRIPE

**PREMIUM VENEER:**

- Available optional finishes on work surface
- Upcharge 20%
- #115 FIGURED ANIGRE
- #116 BIRDEYES MAPLE
- #118 MAHOGANY
- #124 PRIMA VERA-FIGURED

**EXOTIC VENEERS:**

- Avodire
- Bubinga
- Ebony
- Eucalyptus
- Highly Figured Anigre
- Pommele Sapele
- Sycamore
- Wenge
- Other Species Available*

Contrasting color on work surface or conference top requires an upcharge of 15% or \$1720 minimum, whichever is greater. Intricate veneer patterns on entire unit, please contact Customer Service. For exotic veneer on entire unit, please contact Customer Service.

## CONSTRUCTION INFORMATION

### VENEER LAYUP OPTIONS

In addition to our expansive portfolio of standard and exotic veneers, DECCA also offers finely crafted veneer patterns. These handcrafted patterns add a level of aesthetic detail that will give a unique signature to any project. Inspired designs are enhanced by the use of DECCA veneer artwork.

### OPTIONS

Available upon request at an upcharge. Contact DECCA Contract Customer Service at [info@deccacontract.com](mailto:info@deccacontract.com)

### STANDARD

#### BOOK MATCH

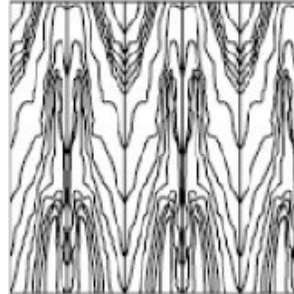

#### SLIP MATCH

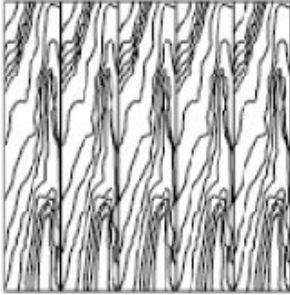

#### DIAMOND

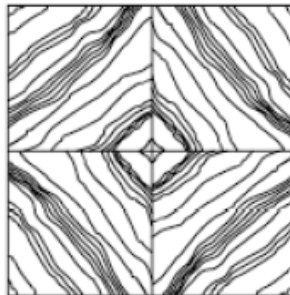

#### REVERSE DIAMOND

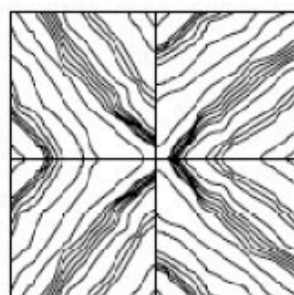

#### BOX

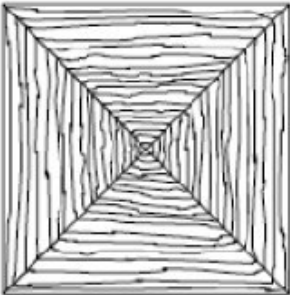

#### REVERSE BOX

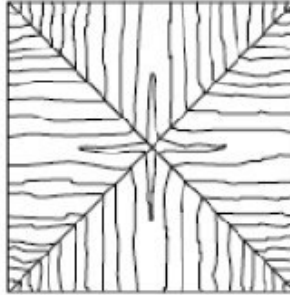

#### SUNBURST

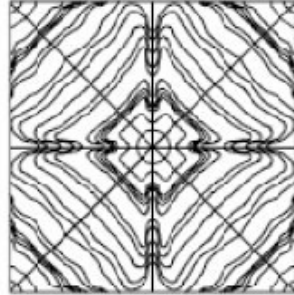

#### CHECKERBOARD

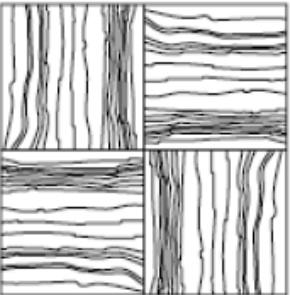

#### HERRINGBONE

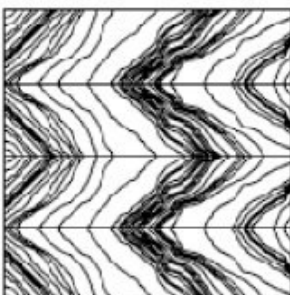

## CONSTRUCTION INFORMATION

### GROMMETS

All cases may be specified with one grommet in a standard position at no charge. A \$57 list upcharge will apply to all grommets requested in non-standard positions. The grommet position must be indicated for each case on the order.

#### Standard:

Round shape solid wood;  
finish same as work surface.

Diameter 3.25"



Identifiers A and C1 are to be used if a grommet is to be located over a desk pedestal. The left or right placement of the pedestal does not change the location identification letter.

Identifiers B and C2 are to be used if a grommet is to be located on a desk worksurface without a pedestal beneath.

Identifier D is for a grommet location in the center of a bridge or return.

Identifier E, G and H is for a grommet location centered in the kneespace.

Identifier F is for a inside corner grommet location.

Grommet holes are located 4.5" from the back of the unit and 9" from the inside edge of the pedestal.

Please keep in mind the location of grommets when specifying paper managers for use with worksurfaces.

Standard wall access 4"x2" on back panel

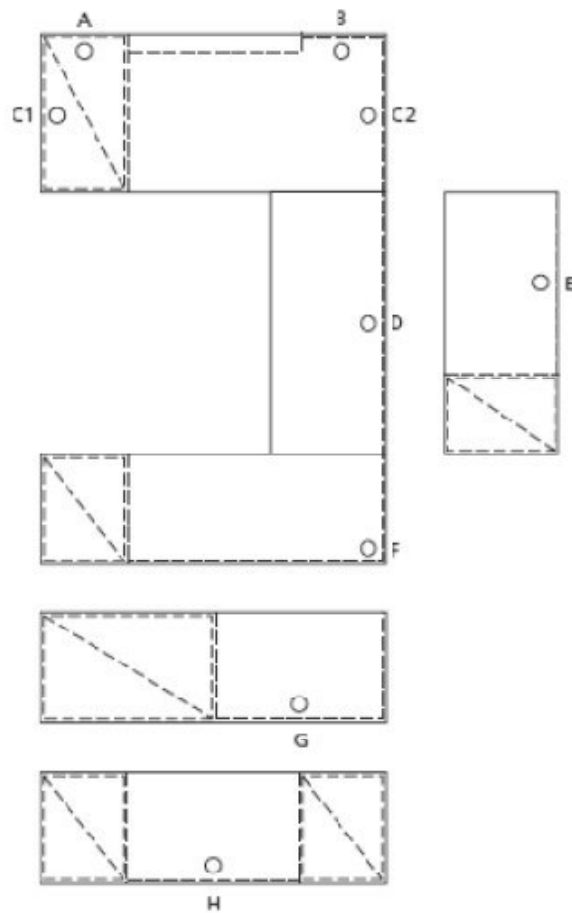
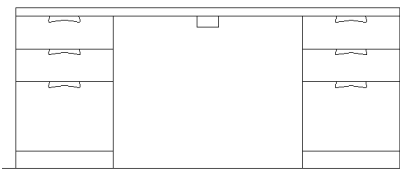

## CONSTRUCTION INFORMATION

### POWER AND TELECOMMUNICATIONS

Decca Contract offers an engineered enclosure for the connection of portable technologies to building infrastructure through the Decca Power Point.

The Decca Power Point combines electrical and ata outlets into one enclosure. The power and data elements are separated by a removable barrier within the enclosure.

The Decca Power Point is both UL and CSA listed with a 8" black power cord and a 15 amp, 125 volt plug. Duplex power receptacles are rated for 15 amps.

The Decca Power Point can be specified hard wire ready to enable a connection to building infrastructure on site by a licensed electrician and following all local electrical code requirements.

- A. Accepts various modular screw-down face plates.
- B. Supports all structured data wiring systems.
- C. Convenient under surface 90 degree trough design.
- D. Durable powder coated 16 guage steel construction.
- E. Electrical and voice/data in a single enclosure.

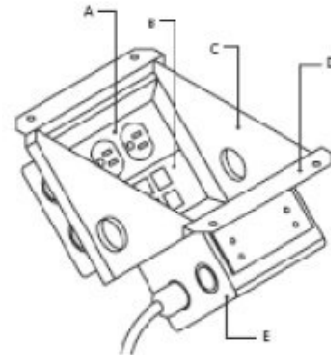

## CONSTRUCTION INFORMATION

### **LOCKS**

Lock plugs are standard and are located on the side panel of pedestal. Locks are optional on door fronts and must be specified at time of order. Suites can be keyed alike at no upcharge, please specify on your purchase order. Lock finish: Black is standard, Silver is available if specified on the order.

### **DRAWERS**

All drawers utilize high precision ball bearing slides to ensure smooth, quiet operation and use three-stage, full extension slides for maximum load capacity. Drawer interiors are veneered with the same veneer and finish as the work surface.

### **DESK PEDESTAL FILE DRAWERS**

Filing Capacity: 24" of letter filing front to back, or 12" legal filing side to side.

### **GLIDES**

Adjustable glides allow for a range of 1" vertical adjustment that can be accessed from the top with a screwdriver.

### **HINGES**

Hinges on doors are standard with 90 degree opening and are self closing. Hinges on glass door are standard with 90 degree opening. Special degree opening hinges are by request only. All hinges are fully adjustable.

### **WALL MOUNT CABINETS**

Wall mounted products are supplied with an adequate mounting device, but not with hardware to attach this device to the support wall. It is the responsibility of the dealer/installer to ensure that the wall structure is adequate to support the product and that the attachment device is properly secured to the wall structure. DECCA is not responsible for damages caused by improper installation of wall mounted products. DECCA is not responsible for damage to our furniture products, building components or property caused by improper installation of wall mounted products. Damage will not be considered a warranty issue.

Proper installation of Decca Contract products is the responsibility of the dealer. Improperly installed products can result in permanent damage to case components. Damage due to improperly installed furniture is not covered under the product warranty.

**MAHARAM TACKBOARD FABRIC****GRADE 1**

Crisp Backed	901420
Crisp Unbacked	901860
Else	901590
Glint	901380
Parallel	901180
Pi	901700
Solo	901580
Twig	901680

**GRADE 2**

Adorn	901440
<b>Chenille</b>	901730
Dialogue	900904
Era	901060
Field	901170
Flip	901150
Frequency	901030
Giga Point	901530
Mega Point	901510
Mega Structure	901490
MegaNano Point	901500
MegaNano Structure	901400
Mingle	901190
Nano Point	901410
Nano Structure	901390
Season	901040

To order samples, or to check stock, please visit [www.maharam.com](http://www.maharam.com)  
or call (800) 45-3943